

EasyStandⁱⁱ Bantam Medium

Please ensure the Owner's Manual stays with the unit at all times.



Owner's Manual

SYMBOL LEGEND



CAUTION/ATTENTION



**ENVIRONMENTAL
CONDITIONS**



TYPE BF APPLIED PART



DATE OF MANUFACTURE



PINCHPOINT



SEE INSTRUCTIONS FOR USE

SN

SERIAL NUMBER



MANUFACTURER



Please be environmentally responsible and recycle this product through your recycling facility at its end of life.

R_xonly

Afin de préserver l'environnement, veuillez confier ce produit à votre centre de recyclage à la fin de sa durée de vie.

Nachdem dieses Produkt ausgedient hat, entsorgen Sie es bitte auf umweltfreundliche Weise, indem Sie es zu der entsprechenden Recyclingstelle bringen.

Wees a.u.b. milieubewust en recycleer dit product via uw recycleerder na het verstrijken van de levensduur.

Sea responsable con respecto al medio ambiente y recicle este producto al finalizar su vida útil en el lugar de reciclaje correspondiente.

Siate responsabili verso l'ambiente e riciclate questo prodotto, al termine della sua vita d'uso, presso la vostra sede di riciclaggio.

Kierrätä tämä tuote sen käyttöiän lopussa ympäristövastuullisella tavalla paikallisella kierrätyslaitoksella.

Var miljomedveten och återvinn denna produkt efter dess användning.

Vi ber deg ta hensyn til miljøet og resyklere dette produktet ved hjelp av de rette resyklingsfasilitetene når produktet ikke lenger kan brukes.

Vis venligst hensyn til miljøet ved at levere produktet til det nærmeste genbrugsanlæg, når det ikke længere fungerer.

Por favor, assumo responsabilidade ambiental, reciclando este produto em suas instalações de reciclagem no final de sua vida útil.

Table of Contents

Introduction	1
Safety Precautions	2
Assembly	3
Adjustments & Usage	16
Pow'r Up Lift Option Usage	24
Options & Parts Detail	29
Maintenance	31
Limited Warranty	32

Date Purchased _____ Serial # _____

Introduction

Congratulations on your purchase of the EasyStand Bantam Medium standing frame! We at Altimate Medical have designed the EasyStand Bantam Medium with your comfort and happiness in mind.

EasyStand Description

The EasyStand line of products is intended for individuals who are able to transfer with assistance from a caregiver and/or lifting device. It is a useful tool for rehabilitation, home, school, and work use. EasyStand standing frames support the user from various positions to the standing position. Various support and positioning options may be added to facilitate individual needs.

Indications for Use

The Bantam Medium is indicated for most individuals weighing up to 200 lbs. and within the height range of 48 to 66 inches.

Intended Use

The EasyStand Bantam products have a manual or electrically operated flat surface that can be adjusted to various positions to increase tolerance to an upright standing position.

This manual is an integral part of your standing system and should be read completely and thoroughly by anyone that will be operating the unit. This will ensure the EasyStand Bantam is assembled properly and used in the most beneficial manner.

It is necessary to inspect your EasyStand Bantam at least weekly to ensure it is in safe operating condition. EasyStand adjustments that are listed in the product owner's manual can be made by the operator by following the instructions for use. After an adjustment is made, inspect the EasyStand to ensure all hardware and adjustable components are properly secured per the instructions for use. Replacement of worn parts, major adjustments, or any other important corrections should be handled by an authorized supplier or service center. Only Altimate Medical, Inc., approved replacement parts should be used to ensure safety and performance.

The EasyStand Bantam shall be prescribed by a qualified physician or occupational/physical therapist. Do not use the EasyStand Bantam without consulting your physician and receiving protocol for a standing program. Failure to consult a qualified physician prior to using the EasyStand Bantam could lead to medical problems. The EasyStand Bantam must be used with a qualified adult attendant present. Should any problems arise that you cannot solve by reading this manual, please contact your local supplier or call Altimate Medical, Inc., at 800-342-8968 or 507-697-6393. only

Join the Standing Community!

Our goal is simple - to empower people with disabilities to stand up for their health. Connect, share, and learn from other people with disabilities, special needs parents, clinical professionals, and the experts in standing on one of our social networking communities.

Read, share, and comment on the EasyStand Blog at blog.easystand.com

Find EasyStand on these social networking sites:



Safety Precautions

- Please read and understand all safety precautions and user instructions prior to use. Call Altimate Medical at 800-342-8968 or 507-697-6393 with any questions or for additional information.
- If a user does not meet the specifications below and has not been properly fitted by a qualified therapist or physician, Altimate Medical, Inc., does not recommend using the EasyStand Bantam Medium.

Bantam Medium- is designed to accommodate most individuals from 48" - 66" (122-168 cm) and up to 200 lbs. (91 kg).

For more detailed specifications visit our website www.easystand.com

- The EasyStand Bantam Medium should not be used without first consulting a qualified physician. Failure to consult a qualified physician prior to using the EasyStand Bantam Medium could lead to severe medical problems. We recommend a good standing program be established and supervised by a qualified, registered physical therapist.
- The EasyStand Bantam Medium should always be used with a qualified adult attendant present. Never leave a child unattended in the Bantam Medium.
- Do not make adjustments to the Bantam Medium while a child is standing. **Exception: If you ordered the supine option refer to pages 17-18. Changes in position must be performed or supervised by a qualified caregiver or medical professional.**
- It is necessary to inspect your EasyStand Bantam Medium at least weekly to ensure it is in safe operating condition. Pay particular attention for loose hardware. If your EasyStand is equipped with the optional Pow'r Up option please inspect the electrical cables for any wear and ensure they are attached properly. Replacement of worn parts, major adjustments, or any other important corrections should be handled by an authorized dealer or service center. Only Altimate Medical, Inc. approved replacement parts should be used to ensure safety and performance.
- If your EasyStand is being used in the home environment, please inspect your unit prior to each use to ensure there is no damage or unexpected wear to the EasyStand that may have been caused unintentionally by pets, pests or children.
- Never reposition the footplates while you are in the standing position. Consult with your therapist or physician for proper foot placement and angle.
- Never elevate the legs or adjust the backrest to anterior tilt using the following arm adjustment. Only the supine option may be used to elevate the legrest with simultaneous recline of the backrest.
- Ensure the necessary support and alignment options are in position prior to placing the user into the standing position.
- If the unit was exposed to temperatures of less than 50°F (23.5°C), the unit must warm to room temperature before use.
- **Operating Conditions:** Temperature: 41°F -95°F (5°C-35°C), Relative humidity: 20% - 90% at 86°F (30°C), Atmospheric Pressure: 700 to 1060hPa.
- **Storage/Transport Conditions:** Temperature: 14°F -122°F (-10°C - 50°C), Relative humidity: 20% - 90% at 86°F (30°C), Atmospheric Pressure: 700 to 1060hPa.
- The EasyStand can be used at a maximum altitude of 3,050 meters (10,000 feet).
- The expected service life of an EasyStand is considered 5 years under normal use conditions. Note: This may vary based on frequency of use.
- If you must transport the EasyStand in a vehicle, secure the unit so it does not move around. After transport inspect the EasyStand to ensure hardware is properly tightened and all options are secured.
- Standing equipment is designed for indoor use on level surfaces only. Keep casters locked while in use.
- It is not recommended to transport the unit with a user in the standing position.
- Extreme movements laterally or front to back may cause the unit to tip.
- It is recommended the equipment be stored at normal room temperature and humidity levels.
- Altimate Medical products are specifically designed to be used with Altimate Medical accessories and options. Unless otherwise noted, accessories and options from other manufacturers have not been tested by Altimate Medical and are not recommended for use with Altimate Medical products.
- Product Modifications made without express written consent (including, but not limited to, modification through the use of unauthorized parts or attachments) are not recommended and will void the product warranty.
- The EasyStand Bantam Medium Electric Lift meets the requirements of IEC 60601-1 and 60601-1-2.*

 **Caution:** The EasyStand is constructed of materials that do not support combustion under normal conditions. For the safety of the patient and attending personnel, do not allow clutter or debris to be stored or accumulate on or around the equipment.

 **Caution:** This equipment is designed to accommodate a range of users; therefore the unit has various adjustment slots and holes. Avoid placing fingers or other body parts in any of these areas.

 **Caution:** While in use this equipment has various moving parts, familiarize yourself with the unit and avoid placing hands or fingers near any of these areas.

 **Caution:** Advise bystanders to keep clear of the unit while in use.

* Bantam Medium Pow'r Up Lift Option Only

Assembly



1. The base model consists of Two 5" Front wheels, Two 5" Rear Locking Casters, Manual Hydraulic Actuator with Handle, Planar Seat, Knee Pads, Height-Only Adjustable Foot Plates, Black Upholstery, Blue Frame Color.



2. Position the unit as shown to install the casters.

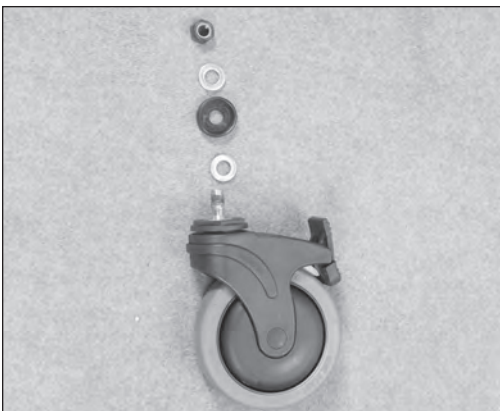

3. Remove the hardware on both casters and set out as shown. This is how the hardware will be assembled. The casters are supplied with a locking compound pre-applied to the threaded stem. Do not remove this material, it is important to prevent the casters from loosening over time.

4A. Place metal washer onto the stud of the caster.

4B. Place the caster onto the unit as shown



5A. Place the black cupped washer onto the caster stud.

5B. Place the second metal washer into the black washer on the caster stud.



6. Place the lock nut onto the caster stud and tighten securely using provided wrench.





7. Place black cap onto the unit to cover hardware.

Repeat these steps for installation of the other rear caster.

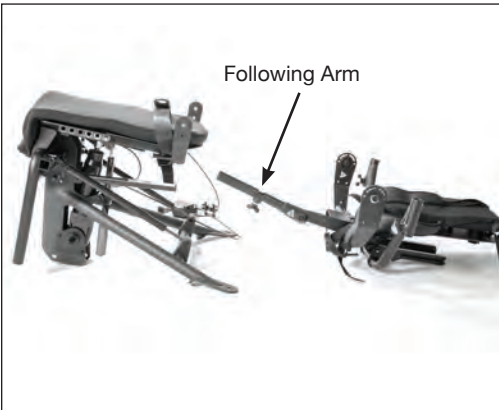

8. Place the unit as shown, if the Back option was **NOT** ordered, skip to step #21.

Place the back as shown and place the following arm as shown.



9A. Remove the screw from the following arm and set the screw aside. You will need this later.

9B. On the following arm, turn the knob all the way loose, flip the gray tab of the knob fully open until it clicks open.

10. Insert the following arm onto the unit until the red color setting is reached on the following arm.

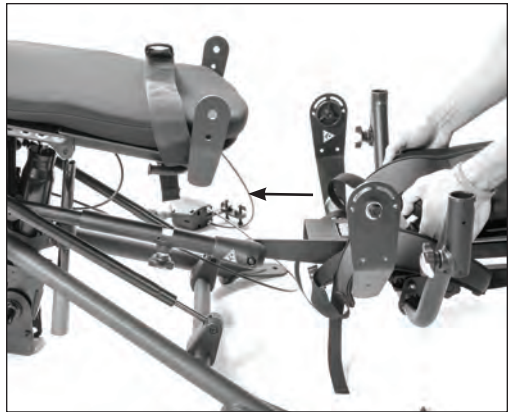

11. Install the screw that was removed onto the following arm and tighten securely. Flip the gray tab closed and tighten knob securely.



12A. Remove the two covers on the hip pivot of the back. There are three small bolts to remove on each cover.

12B. Set covers and bolts aside, these will be needed later.



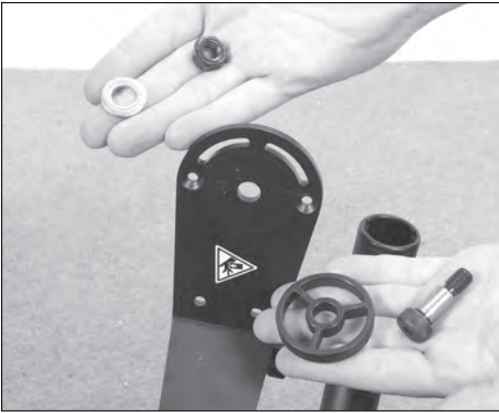

13. Remove the bolt, plastic washer, metal washer, and nut from each side of the unit.

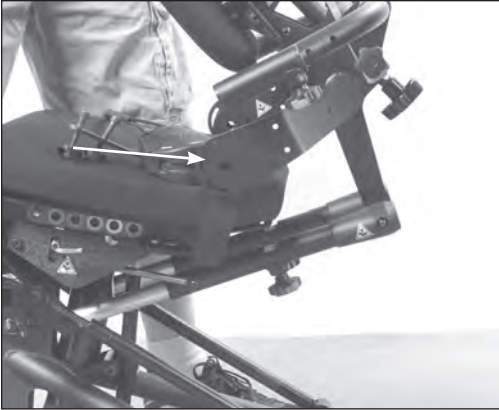

14. With assistance, position the back in the slot on the seat as shown.



15. Line up the holes and place the plastic washer between the back and the slot on the seat, insert bolt from the inside of the unit. Do the same on the other side.

16. Place the metal washer and lock nut onto the bolt.



17. Using an allen wrench and the wrench from the toolkit, tighten the bolt and lock nut **snug**. **Do not overtighten.**

Repeat steps for the other side of the unit.



18. If the Pow'r Up Lift option was ordered, insert bolt onto the bracket on the side of the unit. If the Pow'r Up Lift was not ordered skip to step #20.

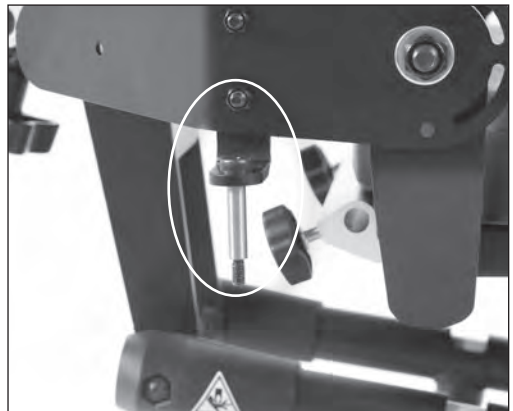

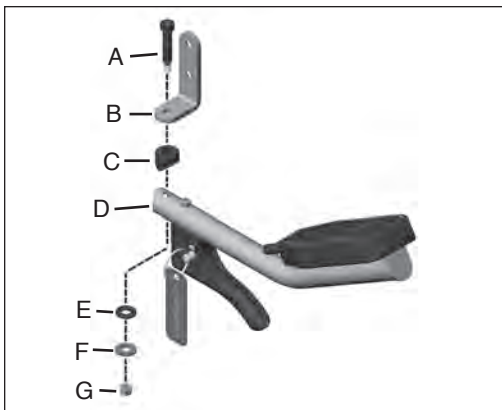

19. Install the controller by assembling as shown.

- A-Bolt
- B-Bracket
- C-Coved Washer
- D-Controller
- E-Coved Washer
- F-Metal Washer
- G-Nut



20A. Place the cover back onto the unit making sure the EasyStand label is not upside down.

20B Replace the top bolt and the bolt on the backside and tighten securely, the third bolt will be installed later.



21. Lock casters, with assistance, position unit as shown.

22. Remove all 4 bolts from the front wheel assembly. With the openings on the bottom of the frame facing down, place the wheel assembly into the seat assembly.



23. Insert all 4 bolts into the base and wheel assembly, make sure to start all 4 bolts, then tighten securely.



24. Place both foot plates on the unit, with the ratchet handle to the outside of the unit.





25A. If the Supine option was ordered, place the unit back on to its wheels. Locate the bolts with the covered washers and nuts on the back of the unit.

25B. Support the covered washer and remove only the nuts. Place the controller bracket onto the bolts.

If the Supine option was not ordered skip to step #28.



26. Place nuts onto bolts and tighten securely.

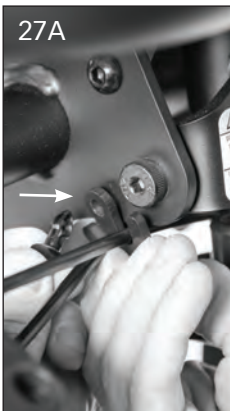

27A. Run the cables inside the adjustment wheel. Insert cables into cable clip. Line cable clip up with hole on unit. Insert push pin fastener to secure.

Note: Cable clips and push pin fasteners will be in a bag on the controller.

27B. Do the same for the other side. Line cable clip up with hole on unit. Insert push pin fastener to secure.

Do not twist cables when installing controller.

For controller usage see pg. 17.

28. If the optional Swing-Away Shadow Tray was ordered, place the tray upside down as shown. Flip the chrome arms as shown, remove 4 bolts from bottom of the tray. Place arm brackets onto tray and line up holes in arm bracket with holes on the tray. Insert 4 bolts and tighten securely.

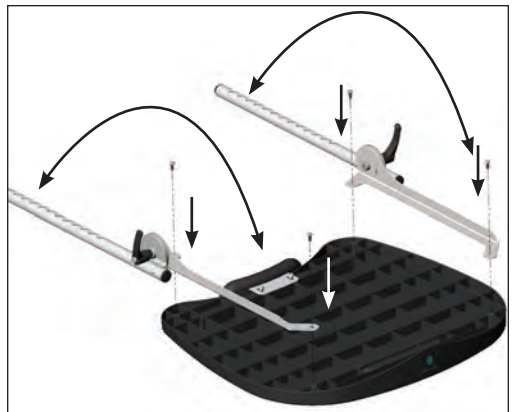

29. Lock the casters, loosen the knobs on the tray receiver all the way then, flip open gray tabs until it clicks. Insert the two tray arms into the tray bracket on the bottom of the tray as shown. (for information on Shadow Tray adjustments see pg. 20).



30. If the swing away shadow tray was ordered, using a wrench, remove the nut from the bolt on the tray arm and discard the nut. Make sure all other hardware stays on the bolt.

⚠ Caution: After placing the tray into position, ensure the ratchet handles on the side of the tray are tightened securely.

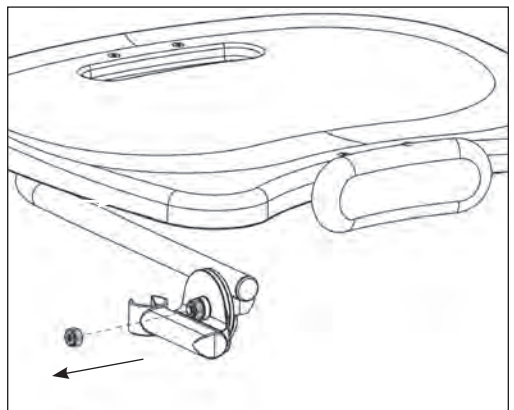

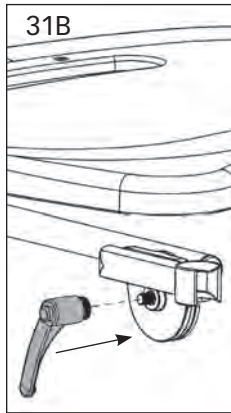
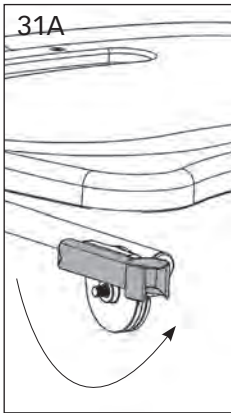

31A. Flip the tray arm as shown.

31B. Place the ratchet handle onto the bolt and tighten securely.

Repeat steps for the other side.



32. There are 2 knobs in the parts bag. Screw each knob into the tray bracket on the unit. Place tray onto unit. Tighten securely.



33. If a Head Support was ordered, loosen the knob and insert Head Support, tighten securely.

34. Insert each knee pad assembly into the tube along the seat post. Depress the spring button to allow the bracket to slide into place, advance until the spring button locks into place. Tighten knobs securely. For Swing-Away knees, place into the tube, and tighten knob securely.



35. Remove knobs (bolts on standard knees) from the knee pads, place the knee pads on the bracket with the larger end of the pad to the outside and the seam side down. Place into desired position and tighten securely.

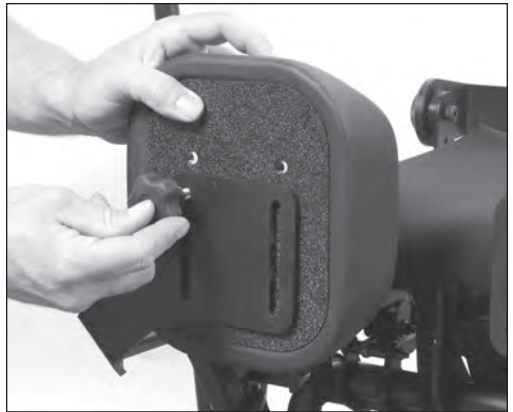

36A. Remove bolts and nuts from the pump handle socket. Place pump handle socket onto pump and align holes. Place bolts through top of the pump handle socket and place nuts on bottom. Tighten securely.

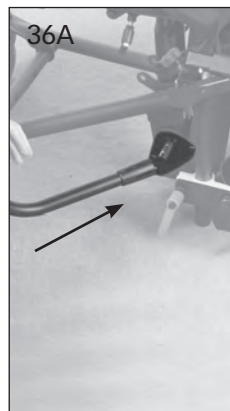

36B. Remove bolts from pump handle top. Place pump handle top on pump handle and align holes. Tighten securely.





37. Pump the unit up until you have access to the third bolt on the hip pivot cover, insert bolt and tighten securely.

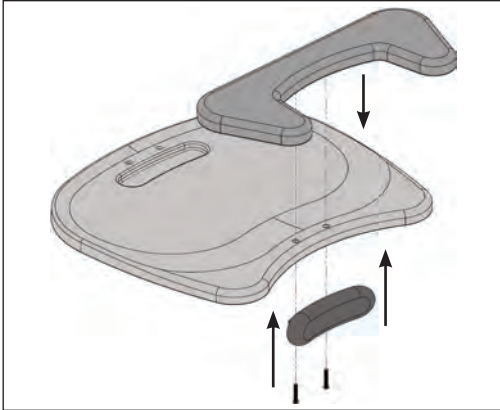

38. If you ordered the optional Elbow Pad Cut out, remove the Chest Pad from tray. Disregard bolts, replace bolts with bolts in the bag with the Elbow Pad Cutout.

Place Elbow Pad Cutout onto the tray. Line up Chest Pad bracket with holes, insert bolts into Tray and Elbow Pad Cutout. Tighten securely.



39A. If the Supine option was ordered, place supine assist handle onto the unit as shown.

39B. Place pull pin into hole to secure the supine assist handle to the unit.

Adjustments & Usage

Read *all instructions* thoroughly before beginning any adjustments.

Seat Depth Adjustment

1. Prior to adjusting seat depth, make sure the Controller is in the "Sit-to-Stand" position. The seat should be lowered to a seated position for easiest adjustment.

2. Loosen the knob on the outer right side of the seat tube frame underneath the seat. One full turn should be sufficient.

3. With one hand supporting the back (if equipped) depress the spring button on the outer left side of the seat tube underneath the seat. Using the back as a lever, move the seat depth to the desired setting, noting the color. If the seat depth does not move freely, check the seat upholstery at the front of the seat to ensure it can slide freely with the telescoping seat surface, you may need to release it from the velcro. Velcro is used to attach it to the front on the unit.

Re-tighten the knob at this time. If the unit is not equipped with a back, the adjustment is complete. Otherwise continue.

4. Loosen the knob on the following arm.

5. With one hand supporting the back assembly flip the gray plunger lever in the center of the knob fully open. Then continue to loosen the knob until resistance is felt. DO NOT continue to turn the knob counterclockwise. Forcing the knob past its stop will damage the mechanism.

⚠ Caution: Make sure to have one hand supporting the back assembly, flipping the gray plunger lever will cause the back assembly to move freely.

6. Using the back as a lever, adjust the following arm so that the color of the seat depth decal matches the color in the indicator window on the following arm (indicator window as shown).

Release the gray plunger lever to re-engage the locking plungers in the clamp knobs. You may need to partially tighten the knob and slightly move the back assembly to allow the locking pin to engage their "home" position. Fully close the gray plunger lever and tighten the knobs securely.

7. After achieving the desired seat depth, rotate the back angle adjustment knob so the seat/back is in the desired angle.



Controller Usage

Go to easystand.com/videos for a short video on the controller usage.

Designed with ease of use and the safety and comfort of the user in mind, the Controller (as shown) is the single point of operation for the supine option.

8. The Controller has 3 positions: Neutral, Sit-to-Stand, and Supine.

9. There is a spring loaded safety collar (red colored) which prevents inadvertent switching between modes. It must be lifted upward into the shift knob before the mode can be changed.

10. Neutral Mode

- The controller should only be set in the neutral position when changing between the sit to stand and supine positioning modes.
- Do not leave the controller in neutral position with a person in the Bantam.
- The neutral position allows the foot bracket supports, and the back support to move freely at the hip and knee pivot points to go into partial supine or full supine.

 **Caution:** If the back angle adjustment has been reclined prior to switching into Neutral mode, the amount of recline will remain relative to its previous adjustment. For example, if the back is adjusted to 10 degrees reclined while the patient is seated, the backrest will be 10 degrees BELOW parallel with the seat if the unit is placed in full supine. For the comfort and safety of the patient, the operator or attendant must be fully aware of back angle adjustment and should confirm “same color” settings on the seat depth and following arm BEFORE switching to Neutral or Supine modes.

Important: All seat depth and following arm adjustments should be made with the Controller in the Sit-to-Stand mode.



Controller Usage

11. Sit-to-Stand Mode

- The unit is locked into sit to stand mode when the foot bracket is locked to the base frame.
- Please note that even though the controller is set to sit to stand mode, the foot plate bracket must be brought perpendicular to the floor and locked into place. If the bracket is not already in position this can be accomplished by pushing on the supine assist handle.
- Listen for a clicking sound to indicate that the unit is locked into sit to stand mode.
- If you can move the back support, or foot supports forward or backward, the unit is not yet locked in sit to stand mode.
- The sit to stand mode allows the user to move between sitting and standing positions. The hip and knee pivot points articulate while maintaining constant angles for the back and foot support bracket.



Controller Usage

12. Supine Mode

⚠ Caution: A properly fitted and adjusted headrest **MUST** be used with the supine option.

The Bantam Medium with Supine Option functions both as a sit-to-stand stander and a supine stander. It may be safely switched between modes at will, without removing the user from the stander.

⚠ Caution: Do not make back angle adjustments while in supine mode.

- The unit is locked into supine mode as soon as the controller is set in that position.
- The foot bracket supports and back support are locked in relation to each other in Supine mode. When in partial supine or full supine the user can be elevated to an upright position or descended to a reclined position.
- If the unit is locked in supine mode, you must only elevate the unit to the point where the footplate bracket comes perpendicular to the floor. **DO NOT CONTINUE TO ELEVATE THE UNIT PAST THIS POINT.** Forcing the unit to elevate past its stopping point could result in damage to the unit.
- The unit is equipped with a Mechlok bypass. This mechanism prevents component damage in the event of over-travel while locked in "Supine" mode. If in supine mode with the legrest assembly up against the seat column (vertical), the Mechlok bypass will be activated. If you wish to maintain supine position while lowering the seat, it is necessary to pull on the supine assist handle a few degrees while lowering the unit until the Mechlok bypass de-activates. If this is not done, the stander will behave as though it is in "Sit-to-Stand" mode, allowing the user to return to a seated position.

⚠ Caution: When in supine mode, if the limit is reached where the foot bracket is perpendicular to the floor, but the user wishes to continue to a straighter standing position you must change the controller to sit to stand mode. This will allow the user to continue toward upright standing without damaging the unit.



Shadow Tray Adjustment

13. To adjust tray depth, loosen each knob as shown all the way loose. Then flip the gray plunger lever in the center of each knob fully open until it “clicks”. Continue to loosen the knob until resistance is felt. DO NOT continue to turn the knob counterclockwise. Forcing the knob past its stop will damage the mechanism.

The tray may now be removed completely, or adjusted to the desired position using the click detent positions as a guide.

14. Release the gray plunger levers to re-engage the locking plungers in the clamp knobs. You may need to partially tighten the knobs and slightly move the tray back and forth to allow the locking pins to engage their “home” positions. Fully close the gray plunger levers and tighten the knobs to secure the tray.

15. To adjust tray angle, loosen one lever clamp approximately 2 turns at either side of the tray where the extension tubes are attached, as shown. Support the tray with one hand before fully loosening the second lever clamp.

16. Move the tray surface to the desired angle and re-tighten both lever clamps securely.

⚠ Caution: Extra care should be exercised if the tray is adjusted with a patient seated in the unit to ensure they are being supported by a chest vest, chest strap or similar supportive device. Lateral guides by themselves, even models with an anterior inward curve, should not be relied upon for frontal support.

⚠ Caution: Never adjust or remove the tray while the patient is standing or in a partially standing position.



Swing-Away Shadow Tray Adjustment

17. To swing-away tray, loosen one knob and swing tray away.

18. To adjust tray depth, loosen knob under tray, set to desired depth and tighten securely.

19. To adjust tray angle, loosen one lever clamp approximately 2 turns at either side of the tray where the extension tubes are attached, as shown. Support the tray with one hand before fully loosening the second lever clamp.

20. Adjust to desired angle and tighten securely

⚠ **Caution:** Extra care should be exercised if the tray is adjusted with a patient seated in the unit to ensure they are being supported by a chest vest, chest strap or similar supportive device. Lateral guides by themselves, even models with an anterior inward curve, should not be relied upon for frontal support.

⚠ **Caution:** Never adjust or remove the tray while the patient is standing or in a partially standing position.

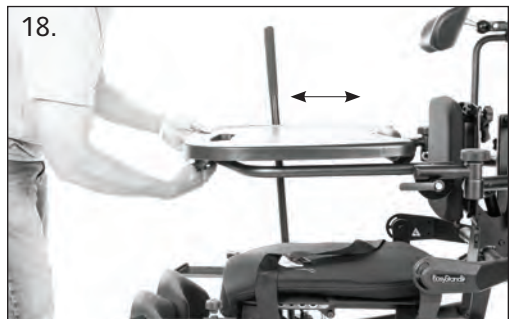

Swing-Away and Shadow Tray Adjustment

21. To adjust the tray height, loosen both knobs on the back of the unit and set to desired position. Tighten knobs securely.



Back Option Adjustment

22. To adjust the back angle, adjust the knob to the desired position.



Lateral Support Adjustment

23. The lateral supports are optional and can be removed for transferring. The lateral support width can be adjusted by loosening the knobs on the back of the unit. Always tighten securely.



The lateral supports have a number of attachment holes on the back of the pad which will allow for additional positions vertically and horizontally. The pads may also be bolted on at a straight, 90°, 180°, or 270° position.

Please check for fit and interference by bringing the unit to the full standing position and back to sitting again without a user seated in the unit. Due to the variety of adjustments that can be made the pads may not work properly in all settings or configurations.

Hip Support Adjustment

24. The hip supports are optional and can be removed for transferring. The hip support width can be adjusted by loosening the knobs underneath the seat. Loosen the knob on the side of the unit to adjust the hip support width. Always tighten securely.



The hip supports have a number of attachment holes on the back of the pad which will allow for additional positions vertically and horizontally. The pads may also be bolted on at a straight, 90°, 180°, or 270° position.

Please check for fit and interference by bringing the unit to the full standing position and back to sitting again without a user seated in the unit. Due to the variety of adjustments that can be made the pads may not work properly in all settings or configurations.

Head Support Adjustment

25. To adjust the head support height, loosen the knob on the back of the back option, move to desired position and tighten securely.

26A. To adjust the head support depth, loosen the knob on the back of the headrest and slide into desired position, tighten securely.

26B. To adjust the head support angle, loosen the ratchet handle and place into desired position. Tighten securely.

Foot plate Adjustment

27. Adjust the foot plate by loosening the red ratchet handle on the foot plate, up or down and to the desired angle, tighten securely. Foot plates maybe be inverted for increased range.

Knee pad Adjustment

28. To adjust the knee pads, loosen the knobs and move into position. Tighten securely once desired position is complete. The standard knee pads have depth and pad rotation adjustments only. The Swing Away Knee pads swing out of the way by depressing the red button, they also have width and height adjustments.

⚠ Caution: Make knee pad adjustments while the user is in the seated position only.

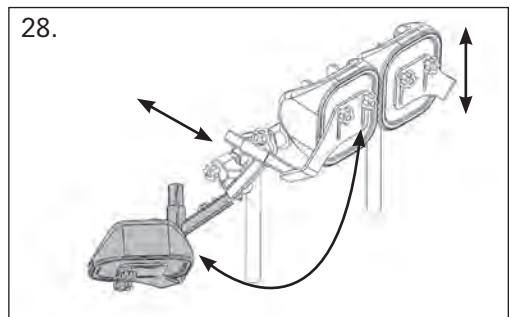

Pow'r Up Lift Option Usage

Charging the Battery

The EasyStand Bantam Medium Pow'r Up Lift uses two 12-volt sealed lead batteries rated at 2.9 amps each. An EasyStand Bantam Medium can be lifted approximately 100 times on one full battery charge. An audible alarm will sound when the battery is low. Please charge the battery after the alarm sounds. A battery needing to be fully recharged will take approximately 8 hours. The EasyStand Bantam Medium can be raised to the standing position while being charged. The function of the charger is to detect a full battery and then provide a constant potential power supply to hold the battery at a full condition without overcharging. When the battery EMF rises to a factory preset point, the charger circuit will not allow the peak output voltage to exceed that value. This factory setting protects a battery from excessive depletion of electrolyte, which can occur from overcharging. The charger can be found in the tool pouch on the back of the unit.

CAUTION: Use only the Linak charger, model number 10CH01S-00, provided by Altimate Medical with the Pow'r Up option.

1. Plug the receptacle into a wall outlet. The length of the charger cable is 80" (203cm). The light on the charger will be green indicating an open circuit.
2. **FIG. A-** Plug the charger cord into the side of the hand control. The light on the charger will turn yellow indicating the batteries are being charged. The length of the hand pendant cable is 30" (76cm), retracted.
3. **FIG. B-** The unit will arrive unplugged from the battery, plug in the white cord that supplies power to the actuator and the black cord that supplies power to the remote. The black cord has a notch on it to orient the connector properly. Fully charge battery before use.
Note: The white cord has a rubber washer on it, which makes it very sticky and sometimes will not get pushed in completely, make sure to push the cord all the way into the battery.
4. When the batteries are charged, the light on the charger will turn green.
5. Fully charge the batteries every three months or less during periods of intermittent or non-use.

CAUTION: The Bantam Medium Pow'r Up Option is not designed for continuous use. Duty Cycle 5% Max, 1 min. / 19 min.

Raising the Lift - Press the UP (arrow up) button on the hand control to lift the seat.

Lowering the Lift - Press the DOWN (arrow down) button on the hand control to lower the seat.

CAUTION: Ensure the cables are attached properly per the instructions for use. Do not allow the cables to drag on the floor or to catch on objects.

FIG. A

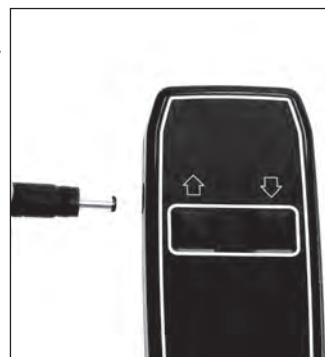

The hand pendant is a Type BF applied part.

FIG. B

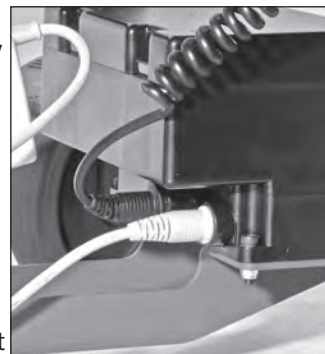

Activating the Mechanical Emergency Release

CAUTION: Using the emergency mechanical release as the primary means of returning to the seated position can cause damage to the unit. Only use the mechanical release in emergency situations.

All Altimate Medical electric lift products are equipped with a mechanical release to be used in emergency situations.

FIG. C-The release allows the user to be lowered to a seated position in the unlikely occurrence of the battery losing charge while the user is in a standing position. The actuator only retracts if the release is pulled and there is weight on the seat. The release is located on the left side of the seat and is signified by a red tag with the word "EMERGENCY."

1. To activate the emergency mechanical release pull out the quick release pin located underneath the seat.
2. Squeeze the handle and if necessary, push down on the handle.

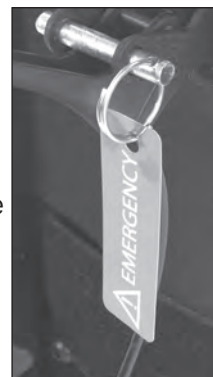

FIG. C

Battery Replacement

The batteries are enclosed in the control box of the Pow'r Up Lift (the black box where the cords are plugged in). Once the batteries have reached their end of life and need to be replaced, do not open the control box; please contact Altimate Medical Customer Service or your medical equipment dealer for information about purchasing a replacement control box. It is recommended that the batteries be replaced every four years.

Please contact a local recycling authority for information about disposing of the old batteries.

IP Rating

The IP rating is a classification system indicating the protection degree from dust, water and impact for electrical equipment and enclosures. Pow'r Up Lift components are rated at IP21. The definition for IP21 is as follows:

First character definition: 2 - Protected against solid foreign objects of 12.5mm diameter and greater.

Second character definition: 1 - Protected against vertically falling water drops.

Electromagnetic compatibility

Pow'r Up Option components have been designed and tested to meet the applicable EMC requirements. It is unlikely that you will encounter problems with your EasyStand due to inadequate electromagnetic compatibility. However, if you notice any unusual (such as intermittent) behavior of your Pow'r Up option and the EasyStand is being used next to possible interfering equipment such as mobile phones, microwaves, or radio broadcast masts, this could be an indication of electromagnetic interference. If such behavior occurs, use the mechanical release to lower the unit to the seated position and move the EasyStand away from the interfering equipment. Please report any instance of possible electromagnetic interference to AMI's Customer Service Department.

Guidance and Manufacturer's Declaration - Electromagnetic Emissions

The EasyStand Bantam Medium is intended for use in the electromagnetic environment specified below. The customer or the user of the EasyStand Bantam Medium should assure that it is used in such an environment.

Emissions Test	Compliance	Electromagnetic Environment - Guidance
RF emissions CISPR 11	Group 1	The EasyStand Bantam Medium uses RF energy only for its internal function. Therefore, its RF emissions are very low and are not likely to cause any interference in nearby electronic equipment. The EasyStand Bantam Medium is suitable for use in all establishments, including domestic establishments and those directly connected to the public low-voltage power supply network that supplies buildings used for domestic purposes.
RF emissions CISPR 11	Class B	
Harmonic emissions IEC 61000-3-2	Class A	
Voltage fluctuations/ Flicker emissions IEC 61000-3-3	Complies	

Guidance and Manufacturer's Declaration - Electromagnetic Immunity

The EasyStand Bantam Medium is intended for use in the electromagnetic environment specified below. The customer or the user of the EasyStand Bantam Medium should assure that it is used in such an environment.

Immunity Test	IEC 60601 Test Level	Compliance Level	Electromagnetic Environment - Guidance
Electrostatic Discharge (ESD) IEC 61000-4-2	± 6 kV contact ± 8 kV air	± 6 kV contact ± 8 kV air	Floors should be wood, concrete, or ceramic tile. If floors are covered with synthetic material, the relative humidity should be at least 30 %.
Electrical Fast Transient/Burst IEC 61000-4-4	± 2 kV for power supply lines ± 1 kV for input/output lines	± 2 kV for power supply lines ± 1 kV for input/output lines	Mains power quality should be that of a typical commercial or hospital environment.
Surge IEC 61000-4-5	± 1 kV line(s) to line(s) ± 2 kV line(s) to earth	± 1 kV line(s) to line(s) ± 2 kV line(s) to earth	Mains power quality should be that of a typical commercial or hospital environment.
Voltage dips, short interruptions and voltage variations on power supply input lines IEC 61000-4-11	<5 % U_T (>95 % dip in U_T) for 0,5 cycle 40 % U_T (60 % dip in U_T) for 5 cycles 70 % U_T (30 % dip in U_T) for 25 cycles <5 % U_T (>95 % dip in U_T) for 5 s	<5 % U_T (>95 % dip in U_T) for 0,5 cycle 40 % U_T (60 % dip in U_T) for 5 cycles 70 % U_T (30 % dip in U_T) for 25 cycles <5 % U_T (>95 % dip in U_T) for 5 s	Mains power quality should be that of a typical commercial or hospital environment. If the user of the EasyStand Bantam Medium requires continued operation during power mains interruptions, it is recommended that the EasyStand Bantam Medium be powered from an uninterruptible power supply or a battery.
Power frequency (50/60 Hz) magnetic field IEC 61000-4-8	3 A/m	3 A/m	Power frequency magnetic fields should be at levels characteristic of a typical location in a typical commercial or hospital environment.

NOTE: U_T is the a.c. mains voltage prior to application of the test level.

Guidance and Manufacturer's Declaration - Electromagnetic Immunity

The EasyStand Bantam Medium is intended for use in the electromagnetic environment specified below. The customer or the user of the EasyStand Bantam Medium should assure that it is used in such an environment.

Immunity Test	IEC 60601 Test Level	Compliance Level	Electromagnetic Environment - Guidance
<p>Conducted RF IEC 61000-4-6</p> <p>Radiated RF IEC 61000-4-3</p>	<p>3 Vrms 150 kHz to 80 MHz</p> <p>3 V/m 80 MHz to 2.5 GHz</p>	<p>3 Vrms</p> <p>3 V/m</p>	<p>Portable and mobile RF communications equipment should be used no closer to any part of the EasyStand Bantam Medium, including cables, than the recommended separation distance calculated from the equation applicable to the frequency of the transmitter.</p> <p>Recommended separation distance</p> $d = 1.2 \sqrt{P}$ $d = 1.2 \sqrt{P} \text{ 80 MHz to 800 MHz}$ $d = 2.3 \sqrt{P} \text{ 800 MHz to 2.5 GHz}$ <p>Where P is the maximum output power rating of the transmitter in watts (W) according to the transmitter manufacturer and d is the recommended separation distance in meters (m).</p> <p>Field strengths from fixed RF transmitters, as determined by an electromagnetic site survey^a, should be less than the compliance level in each frequency range.^b</p> <p>Interference may occur in the vicinity of equipment marked with the following symbol:</p> <div style="text-align: center;">  </div>

NOTE 1: At 80 MHz and 800 MHz, the higher frequency range applies.

NOTE 2: These guidelines may not apply in all situations. Electromagnetic propagation is affected by absorption and reflection from structures, objects, and people.

^a Field strengths from fixed transmitters, such as base stations for radio (cellular/cordless) telephones and land mobile radios, amateur radio, AM and FM radio broadcast and TV broadcast cannot be predicted theoretically with accuracy. To assess the electromagnetic environment due to fixed RF transmitters, an electromagnetic site survey should be considered. If the measured field strength in the location in which the EasyStand Bantam Medium is used exceeds the applicable RF compliance level above, the EasyStand Bantam Medium should be observed to verify normal operation. If abnormal performance is observed, additional measures may be necessary, such as re-orienting or relocating the EasyStand Bantam Medium.

^b Over the frequency range 150 kHz to 80 MHz, field strengths should be less than 3 V/m.

Recommended separation distances between portable and mobile RF communications equipment and the EasyStand Bantam Medium

The EasyStand Bantam Medium is intended for use in an electromagnetic environment in which radiated RF disturbances are controlled. The customer or the user of the EasyStand Bantam Medium can help prevent electromagnetic interference by maintaining a minimum distance between portable and mobile RF communications equipment (transmitters) and the EasyStand Bantam Medium as recommended below, according to the maximum output power of the communications equipment.

Rated maximum output power of transmitter W	Separation distance according to frequency of transmitter m		
	150 kHz to 80 MHz $d = 1.2 \sqrt{P}$	80 MHz to 800 MHz $d = 1.2 \sqrt{P}$	800 MHz to 2.5 GHz $d = 2.3 \sqrt{P}$
0.01	.12	.12	.23
0.1	.38	.38	.73
1	1.2	1.2	2.3
10	3.8	3.8	7.3
100	12	12	23

For transmitters rated at a maximum output power not listed above, the recommended separation distance d in meters (m) can be estimated using the equation applicable to the frequency of the transmitter, where P is the maximum output power rating of the transmitter in watts (W) according to the transmitter manufacturer.

NOTE 1: At 80 MHz and 800 MHz, the higher frequency range applies.

NOTE 2: These guidelines may not apply in all situations. Electromagnetic propagation is affected by absorption and reflection from structures, objects, and people.

Options & Parts Detail

ITEM NO.	PART NO.	NAME
1	Y5500	BANTAM MEDIUM BASE UNIT
2	Y5528	ASMBLY BACK BANTAM MED
3	Y5530	BACK REST PLANAR 16"
4	Y5532	BACK REST PLANAR 20"
5	Y5548	ASMBLY HEAD REST
6	Y5554	ASMBLY SUPINE OPTION BANTAM MED
7	Y5560	ASMBLY HIP GUIDES BANTAM MED
8	Y5562	ASMBLY LATERAL GUIDES BANTAM MED
9	Y5564	ASMBLY ELECTRIC LIFT BANTAM MED
10	Y5566	ASMBLY FRONT NO-TABLE BANTAM MED
11	T30062	HEAD SUPPORT BANTAM XS
12	T30065	HEAD SUPPORT BANTAM SMALL
13	NG30299	HEAD SUPPORT EVOLV LARGE
14	Y5570	ASMBLY SEAT CONTOUR NARROW
15	Y5572	ASMBLY SEAT CONTOUR WIDE
16	Y5574	ASMBLY BACK CONTOURED 16"
17	Y5576	ASMBLY BACK CONTOURED 20"
18	Y5586	ASMBLY FOOT MULTI-ADJ LARGE
19	Y5596	ASSEMBLY KNEES SWING AWAY
20	Y5600	ASSEMBLY KNEE PADS ROHO
21	Y3008	STRAP CHEST/ LAP BANTAM MEDIUM
22	Y5602	ASMBLY TABLE MULTI-ADJUSTABLE
23	Y5604	ASSEMBLY TRAY STANDARD
24	Y5606	ASSEMBLY TRAY CLEAR
25	Y5568	SWIVEL FRONT BANTAM MED
26	T50170	H-FRAME BANTAM SWIVEL WHEEL
27	Y3014	POSITIONING BELT W/BUCKLE MED
28	NG50040	HANDLE PUSH ASSEMBLY
29	Y5632	HANDLE PUMP REMOVEABLE/ADJ MED
30	NG50044	QUAD GRIP OPTION
31	NG50070	ACTUATOR HANDLE EXTENSION EVOLV LG
32	NG30170	X-STYLE CHEST VEST MEDIUM
33	NG30056	LARGE CHEST VEST EVOLV
34	NG30171	Y-STYLE CHEST VEST 17.5"L X 11.5"W
35	NG30021	VEST CHEST Y SHAPE ASSEMBLY LARGE
36	Y5620	ASMBLY CHEST STRAP WITH PAD
37	T50156	ASSEMBLY ELBOW PAD 9.25" CUTOUT
38	T50160	ASSEMBLY ELBOW PAD 11" CUTOUT
39	Y5582	ASSEMBLY ELBOW PAD 13"
40	NG30000	PAD FRONT EXTRA SUPPORT
41	NG30295	PADDED TRAY COVER
42	Y5636	ASMBLY FOOT STRAP 15"L
43	Y5638	ASMBLY FOOT STRAP SECURE 15"L
44	Y5634	ASMBLY CHEST VEST BRKT HIGH MOUNT
45	Y5645	ASMBLY BEARING SEAT DEPTH
46	NG50042	SUPPORT GRIP OPTION
47	80809	TOOL POUCH
48	Y5643	ANGLE LOCATOR MED BANTAM
49	Y5653	ASMBLY TABLE MOUNT SWINGAWAY MED
50	Y5654	ASMBLY TRAY SWINGAWAY MED - BLACK
51	Y5655	ASMBLY TRAY SWINGAWAY MED - CLEAR
52	Y5662	ASSIST HANDLE MED BANTAM
53	Y3041	COVER BACK PLANAR 16" DARTEX
54	Y3040	COVER BACK PLANAR 20" DARTEX
55	Y3045	COVER BACK REST CONTOURED 16" DARTEX
56	Y3046	COVER BACK REST CONTOURED 20" DARTEX
57	Y3043	COVER CONTOURED SEAT NARROW DARTEX
58	Y3044	COVER CONTOURED SEAT WIDE DARTEX
59	Y3042	COVER SEAT PLANAR MEDIUM DARTEX

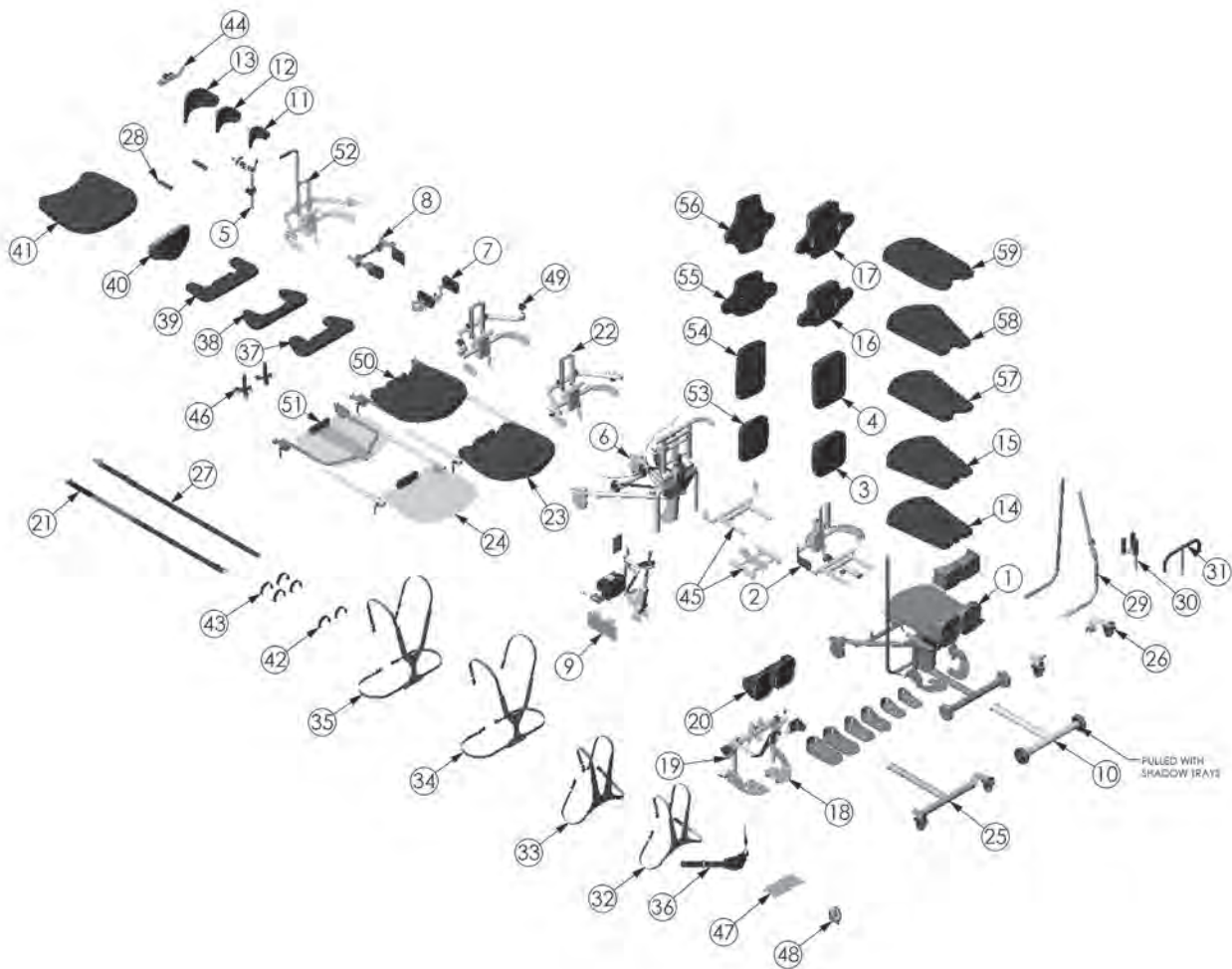

Maintenance

Cleaning/Disinfecting

- Clean the EasyStand with a mild, non-abrasive disinfectant or soap and water.
- Check the EasyStand at least weekly to ensure all nuts, bolts and adjustable parts are tightened securely, failure to do so may result in parts falling off which may cause a choking hazard for children.
- Do not use bleach or any other bleach-based cleaners on the EasyStand.
- Disinfecting wipes are safe to use on metal and non-porous surfaces.
- Use a damp sponge with mild soap or a mild, non-abrasive disinfectant.
- Spot clean Neoprene with mild soap and water.
- Neoprene covers may be removed and hand washed with water. Air dry the covers. Always use care when removing and replacing the covers.
- Do not dry clean any upholstery items.
- If the EasyStand is being used with one user, clean the EasyStand on a monthly basis or as needed.
- If the EasyStand is being used in a multiple-user environment, the EasyStand should be cleaned after each use.

Urethane Coated Fabrics (Dartex or generic equivalent)

- The recommended cleaning and disinfection instructions should be followed whenever possible to avoid damage to the PU membrane which could lead to premature failure of the cover.
- For superficial dirt, use a disposable wipe and a warm solution of neutral detergent. Do not use abrasive cleaners.
- Disinfect using a 0.1% sodium hypochlorite solution (1000ppm chlorine), stronger bleach solutions not recommended.
- Thoroughly rinse any remaining cleaning solution with water and dry fabric before re-use or storage.
- Do not iron.

Hydraulic Actuator Maintenance

- An initial break-in period of approximately 50-100 full cycles is normal for the hydraulic unit. The very close fit of its mating parts gives each pump its own break-in "feel" and signature sound, signaled by a squeaking or a less-than-smooth stroke.
- If the pump is leaking oil or not holding properly contact your local EasyStand Supplier for a replacement.
- Do not exert excessive force on the pump handle or use the pump handle to move an EasyStand. This may cause damage to the pump handle and/or the pump mechanism and will void any warranty.
- User maintenance is not required or recommended on the hydraulic pump. Never apply lubricant, household oil, grease, or a similar product to any part of the unit. Some compounds may react with the seals used in the manufacture of this product. This may damage the unit and will void any warranty.
- Do not exceed the rated weight limit.
- If the EasyStand was shipped and exposed to a temperature of less than 50 degrees Fahrenheit, the hydraulic unit must warm to room temperature before use. Failure to follow this step could damage the unit and render it inoperable.
- Once the standing position is reached, the pump may settle back one stroke, this is normal.
- It is not always necessary to push the pump handle all the way back to lower the seat. Try pushing the handle back in different positions if it is difficult to lower the seat.
- If the unit is in the standing position and unoccupied, it is necessary to apply pressure to the seat of the unit while pushing the pump handle back.

Purging The Hydraulic Actuator

The hydraulic pump on the EasyStand has a high probability of getting air trapped in the internal workings of the unit. This is usually caused by in-transit handling and is quite normal. Please follow the simple steps below, as manual hydraulic systems may never operate properly unless the entrapped air is correctly purged. The unit must be at room temperature for this procedure.

1. Pump the handle until the full extension is reached.
2. Now continue pumping the handle slowly for an additional 10 strokes. This will properly purge the system.

Limited Warranty

This warranty is extended only to the original purchaser/customer (or supplier non consumer who does not buy or resell). Altimate Medical, Inc., warrants the EasyStand against defects in materials and workmanship as listed below.

- Steel Frames - 5 year warranty
- Hydraulic Actuator - 2 year warranty
- Upholstered components, plastic pads, rubber parts, painted surfaces, bearings and other parts not specifically identified above - 90 day warranty

Warranty on Electric lift option components is as follows:

- Actuator & Hand Pendant – 2 year warranty
- Control Box & Battery – 90 days
- Battery Charger – 90 days

The warranty period commences on the original ship date from Altimate Medical. Any product proven to Altimate Medical satisfaction to be defective and within warranty period, shall be repaired or replaced at Altimate Medical's option.

ALTIMATE MEDICAL SOLE OBLIGATION AND YOUR EXCLUSIVE REMEDY UNDER THIS WARRANTY SHALL BE LIMITED TO SUCH REPAIR AND/OR REPLACEMENT. This warranty does not include any labor charges incurred in replacement parts installation. Freight charges to factory are at the expense of consumer to seller. Return freight charges will be prepaid by Altimate Medical. For warranty service, please contact the authorized supplier from whom you purchased your Altimate Medical product. In the event you do not receive satisfactory warranty service, please write directly to Altimate Medical at the address below. Do not return products to our factory without prior authorization.

LIMITATIONS AND EXCLUSIONS: The foregoing warranty shall not apply to serial numbered products if the serial number has been removed or defaced. Products subject to negligence, abuse, misuse, improper operation, improper maintenance, improper storage, or damages beyond Altimate Medical's control are not covered by this warranty, and that evaluation will be solely determined by Altimate Medical. Products modified without Altimate Medical's express written consent (including, but not limited to, modification through the use of unauthorized parts or attachments) are not covered by this warranty. The warranty shall not apply to problems arising from normal wear or failure to follow instructions. The warranty will be void if parts not manufactured by Altimate Medical or parts not complying with original equipment specifications are added to an Altimate Medical product.

THE FOREGOING WARRANTY IS EXCLUSIVE AND IN LIEU OF ALL OTHER EXPRESS WARRANTIES. ALTIMATE MEDICAL SHALL NOT BE LIABLE FOR ANY CONSEQUENTIAL OR INCIDENTAL DAMAGES WHATSOEVER.

Altimate Medical maintains a policy of continual product improvement and reserves the right to change features, specifications, and prices without prior notification. Check with Altimate Medical for latest information.

Altimate Medical, Inc., 262 W. 1st St., Morton, MN 56270 USA
Phone: 507.697.6393 Fax: 507.697.6900 800.342.8968
easystand.com info@easystand.com

Environmental Issues

After life of the product:

- Recycle in accordance with the recycling codes of your country.
- Recycle all metal parts.
- Plastic parts should be disposed of or recycled according to the directive in your country.
- Please inquire at your local disposal management and recycling center for local codes.
- Return hydraulic actuator or damping cylinder (Pow'r Up only) to Altimate Medical, Inc.



AltimateMedical

EasyStand 

262 West 1st St.
Morton, MN 56270 USA
Toll Free: 800.342.8968 or 507.697.6393
Fax Free: 877.342.8968 or 507.697.6900
email: info@easystand.com
easystand.com

EasyStand  
standing made easy



Standing technology should only be used under the guidance of a physician with recommendations for standing program protocol and any medical precautions. Standing programs should be monitored by the attending therapist. AMI maintains a policy of continual product improvement and reserves the right to change features, specifications, and prices without prior notification. Check with AMI for latest info.
FORM MBANMAN 102218 REV D Copyright © 2018 Altimate Medical, Inc. All rights reserved. Printed in the U.S.A.