

CARROT 3 BOOSTER SEAT - CHILD RESTRAINT SYSTEM
For Children with Special Needs

Instruction Manual

Convaid
CARROT
3

WARNING
Read all instructions
before using this
restraint system.



CARROT 3 CHILD RESTRAINT SYSTEM

The Carrot 3 Booster Seat is an extended version of the standard Carrot 3 child restraint system. The Carrot 3 Booster Seat offers a larger configuration to meet the needs of children that require additional seat growth that is not available on the standard Carrot 3. Always consult your doctor to make sure that this restraint system is suitable for your child.

Your child's safety is very important to us. To ensure that your restraint system is installed correctly, please read all the instructions in this manual before using. If you require additional assistance, please call Convoid at (888) 266-8243.

Sole importer in Americas:

Convoid
2830 California Street
Torrance, CA 90503
Phone: 888-266-8243 • 310-618-0111
Fax: 310-618-2166

Table of Contents

Warnings	3
Safety Information	5
Important Notes	5
Certification	6
Features	7
Installation	8
Standard Installation	8
Functions	9
Head Support Adjustment	9
Depth Adjustment	9
Forward / Backward Positioning	9
Head-Pillow Adjustment	9
Shoulder Support	10
Shoulder Width Adjustment	10
Shoulder Straps Comfort Pads	10

Table of Contents

Backrest	11
Backrest Height Adjustment	11
Backrest Extensions 4" (100mm)	11
3D Body Balance Pads	11
4-Point H-Harness	12
Harness Buckle	12
Accessories	14
Support Tray	14
Seat Wedge	14
Securing Your Child	15
Warning	17
Warning	17
Care and Maintenance	19
Cover Removal	19
Upholstery, Cushions, Pillow & Pads	19
Harness Buckle	19
Harness Strap	19
Product Dimensions	20
Warranty	20
Limited Five Year Warranty	21
Warranty Limitations	22
Limitations of Damages	22
Limited Warranty	22



WARNING !
DEATH or SERIOUS INJURY can occur

- Recommended for use with children who have outgrown the Carrot 3 car seat. Suggested guidelines are children who weigh more than 79lbs (36kg) and less than 165lbs (75kg) with height between 4.5ft (140cm) and 5.7ft (175cm). It has been successfully crash tested.
- Use in forward-facing only.
- Never alter construction of the Carrot 3 Booster Seat child, unless specially authorized in the instruction manual.
- Adjust the belts provided with this child seat so they fit snugly around your child. A snug strap should not allow any slack or twist. It does not press on the child's skin or push the child's body into an unnatural position.
- Secure child restraint system with the upper and lower fixing straps to the vehicle's seat, and always use vehicle's lap shoulder 3-point safety belts as well.
- Fasten the harness 4-point of the child restraint system as well as the vehicle's lap shoulder 3-point safety belt to secure your child in a firm position.
- Follow all the instructions on this child restraint system and in this instruction manual.
- Use this child restraint system only with vehicles provided with lap shoulder 3-point safety belts approved by ECE regulation No.16 or other equivalent standards.
- The rigid items and plastic parts of the child restraint system must be located and installed in away so they don't become trapped by a movable seat or in a door of the vehicle.
- To prevent injury due to hidden damage, discontinue use of a child restraint system that has been in any type of car crash.
- This child restraint system must be used with the cover.



WARNING !
DEATH or SERIOUS INJURY can occur

- The child restraint system cover should only be replaced with the one recommended by the manufacturer.
- This instruction manual should be stored in the pocket on the back of the child restraint system.
- This child restraint system is not for use in the home, in boats, or other non-certified applications.
- The back seat of vehicle is the safest location for a properly installed child restraint system. Please comply with safety standards set in your vehicle owner's manual, to ensure your child's safety.
- Secure this child restraint system seat even when it is not occupied. In a crash, an unsecured child seat may injure vehicle occupants.
- When using in a vehicle with airbags, refer to your vehicle's owner's manual for child restraint system installation instructions and precautions.
- Never use the adjuster strap to lift or carry this child restraint system. Doing so will cause damage to the harness adjuster and webbing. Always carry this child restraint system by its shell.
- Do not take the child restraint system apart or attempt to take apart the harness and the straps from the child seat. Do not remove the buckles and / or the buckle tongues from the harness or the straps. They cannot be reattached after removal. If reassembled incorrectly, the child restraint system may not perform optimally.
- The primary protection for occupants of a vehicle in a collision is the body of the vehicle itself; a child restraint system will not protect a child when a vehicle is seriously impacted. However, correctly installed, a child restraint system will substantially improve chances for survival in most crashes. Make sure all users fully understand proper use of this child restraint system in a vehicle.

Safety Information

Important Notes

- Make sure that the child restraint system is properly secured with the provided upper and lower fixing straps, and harness is properly adjusted around the child each time the child restraint system is used.
- Adjust the harness to accommodate and fit the occupant's clothing.
- Cover the child restraint system when vehicle is parked in direct sunlight. Parts could become very hot and could burn the occupant.
- Store child restraint system in a safe place when not in use. Avoid placing heavy objects on top of it.
- Never leave occupant unattended in a vehicle, even for a short period of time.
- Do not, except as described in this manual, attempt to disassemble any part of the child restraint system or change the way its harness or vehicle's seat belts are used.
- Do not leave loose objects (e.g. books, bags, etc.) in the back of a vehicle; in the event of a sudden stop, loose objects could potentially causing serious injuries.
- Do not leave folded vehicle seats unlatched. In the event of a sudden stop, a loose seat back could prevent the child restraint system from protecting the occupant as it should.
- Do not use anything to raise the child restraint system off the vehicle seat except as described in this manual. In a crash, the child restraint system could slide and may not protect the occupant.
- Do not allow children to play with this child restraint system.
- It is recommended that the child restraint system is used in an upright positioning only.

Certification

- This child restraint system is designed for occupants who weigh more than 79lbs (36kg) and less than 165lbs (75kg).



WARNING!

This child restraint system must only be used in forward facing position.



WARNING!

When you recline the back, you must release and loosen the harness straps first, then after reclining the back, re-tighten the harness. Reclining the back without loosening the harness may cause bodily injury or choking.

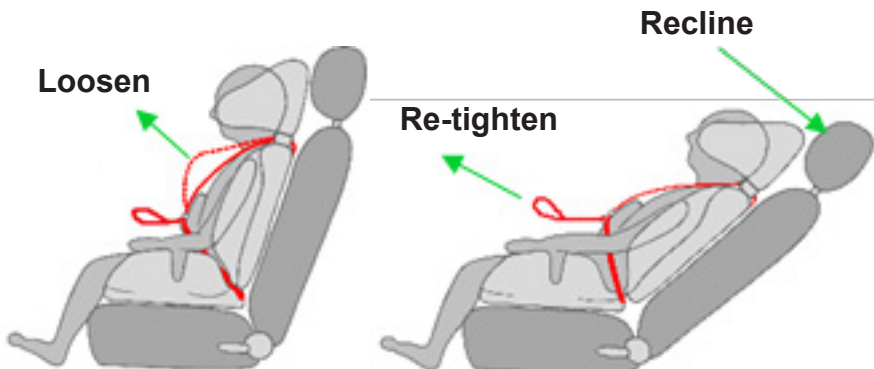

Features

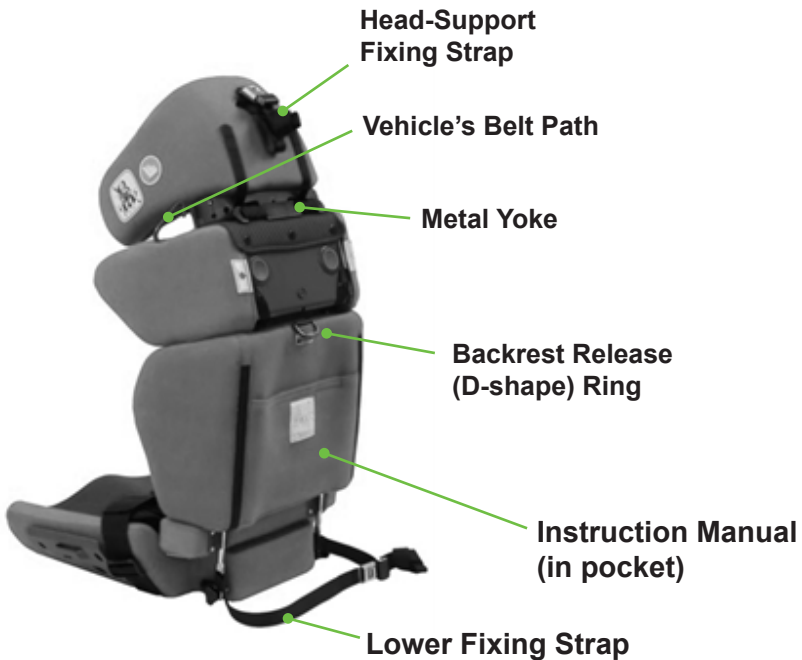

Instructions

Fixing Straps

1. Install the fixing straps at the upper and lower parts of the child restraint system.
2. Secure the child restraint system's head support using the head support fixing strap, and use the lower fixing strap to secure the child restraint system to vehicle's seat.
3. Attach the buckles, and snugly fit the child restraint system seat into the vehicle seat while pulling both adjuster straps tightly to remove all slack. Ensure the child restraint system is tightly secured (Fig. A and B).
4. Verify all connectors are secure and that the child restraint system is secure.
5. When installing the child restraint system onto the passenger seat, avoid potential airbag impact by moving the passenger seat as far back as possible.
6. When you install the child restraint system to a bench-seat you may find that the fixing strap is too short, in this instance, you may fix child seat by using the strap vertically (Fig. C).
7. If you have difficulty securing the child restraint system, please contact the distributor or the retailer where you purchased this child restraint system for consulting.

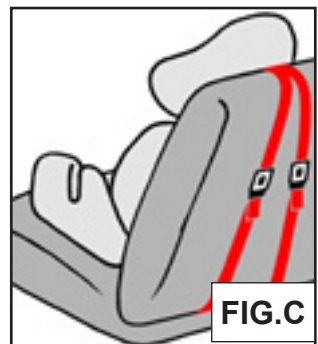
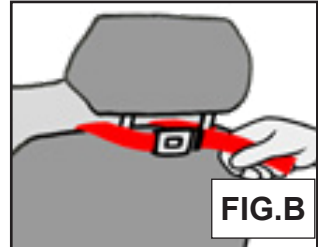
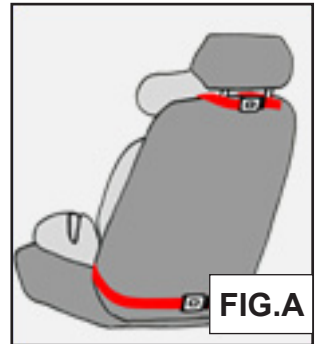

Functions

Head Support

Head Support Adjustment

The Head-Support Depth can be adjusted forward or backward by 0.6" (15 mm) increments to provide a better fit and added protection for the occupant.

To Adjust: Pull out the Head-Support from the main body, and remove screws on each side at the bottom (Fig. A).

Move the Head-Support to selected position, and reinsert the screws (Fig. B).

Note: Standard setting is at center position.



FIG.A

IMPORTANT:

Adjustment of the Head-Support position (forward / backward) requires fixing tools. Contact and ask your dealer for adjustment assistance.

Head Pillow Adjustment

The Head Pillow can easily be adjusted to the most favorable position to the user.



FIG.B



Shoulder Support

Shoulder Width Adjustment

The Shoulder Protector wing can be extended by 4" (100mm), by extending the right and left sides by 2" (50 mm) each.

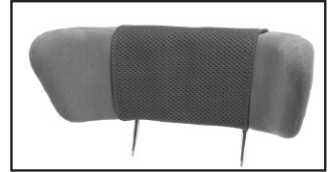

To extend the Shoulder Protector wing by 4" (100 mm) you must move the wing to the fifth position. This is achieved by pressing on the yellow button on the back of the unit, while simultaneously pulling the wing outward toward you until it is in the desired position. Each position "stop" allows the wing to increase by approximately 0.5" (10 mm).

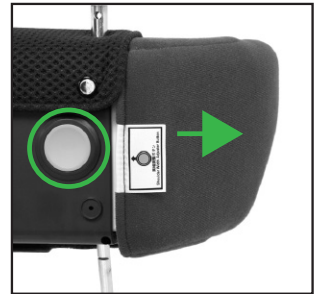

IMPORTANT:

When your child becomes big enough to use the Shoulder Protector Wings, you can purchase the Shoulder Protector Wings for a larger child.

You must contact and ask your dealer for the installation and adjustment of the set.

Padded Covers

You can adjust the Padded Covers to the favorable position by moving the Velcro® tape attached to the back of the Head-Support.

NOTE: Do not pull the Padded Covers on the harness strap as it is fixed on the back. Pull and loosen the harness strap only.



Functions

Backrest Support

IMPORTANT:

- The height of the Shoulder Harness Strap moves with the height of the Backrest.
- The level of the Shoulder Harness Strap must be at or above the occupant's shoulders, parallel to level ground.

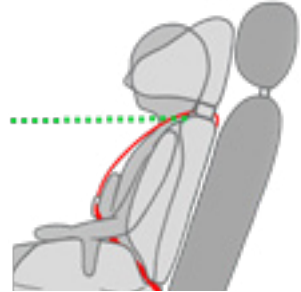

Adjusting Backrest Height

Release the locking by pulling the Backrest Release (D-shape) ring on the back of the occupant child seat. While pulling the strap, adjust the height of the Backrest.

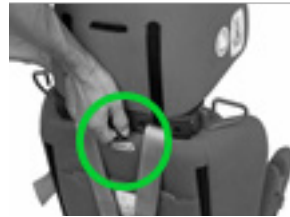

Backrest Extension 4" (100 mm)

Backrest Extensions fill the space exposed between the Backrest and the seat when you extend to the Backrest.



3D Body Balance Pads

Ergonomic three dimensional shaped pads for better positioning of the child's body.



4-point H-Harness

Fastening / Releasing Harness Buckle

1. Hold the harness buckle with one hand. Use the other hand to insert the buckle tongue into the harness buckle (Fig. A).
2. Hold the harness buckle with one hand. Push and release the buckle tongues and slide out to remove from the buckle (Fig. B).

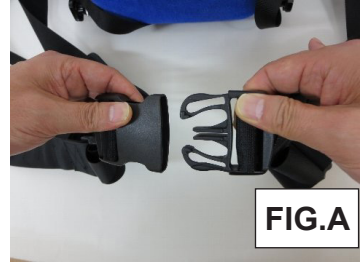

Functions

Accessories

Support Tray

The X-Large support tray is designed specifically for the booster seat and may be used to secure the child's upper limbs.



Seat Wedge

Use to increase and adjust the height and angle of the front area of the seat for better secure and stability of seating.

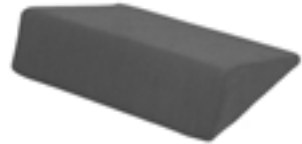

Secure Occupant

Once The Carrot 3 Booster Seat has been installed in the vehicle's seat and adjustments have been made, follow these instructions to secure the child.

- Loosen the harness and unfasten the harness buckles (upper and lower). Move the harness straps to the side of the seat (Fig. A).
- Place the child in the seat (Fig. B).
- Position the harness strap around the child and verify the harness is not twisted or tangled (Fig. C).
- Fasten the lower harness buckle first. Proper connection is confirmed with a positive click after inserting the buckle tongue (Fig. D).
- Gently pull the harness strap to the side to tighten the lap section (Fig. E).

Note: The child's hip should be positioned as deep as possible in the seat to firmly secure the child.

- Next, fasten the upper harness buckle on the chest. Proper connection is confirmed with a click after inserting the buckle tongue (Fig. F).
- Gently pull down the harness straps to tighten the shoulder section.

WARNING

In order to avoid injury or choking the child, always manually test the straps to ensure child's safety and comfort (Fig. H).

Reconfirm that the 4-point harness is not twisted and the child is properly secured.

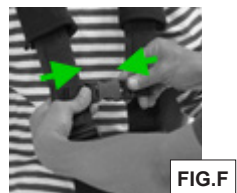
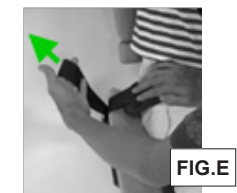
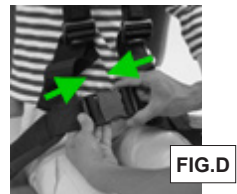

Secure Occupant

- After you secured the child with the 4-point harness, fasten the vehicle's lap shoulder 3-point safety belt over the Carrot seat routing through the RED belt guides on the child seat's shoulder (Fig. I and J).
- Proper connection is confirmed with a click sound after inserting the buckle tongue of the vehicle's lap shoulder 3-point safety belt into the buckle of the vehicle's seat.
- Verify that vehicle's lap shoulder 3-point safety belt is not twisted or sagging, and is properly routed through the RED belt guide (Fig. I and J).
- Ensure that the vehicle's lap shoulder 3-point safety belt is positioned not to harm the face and the neck of the child.
- It is required by law to use the vehicle's lap shoulder 3-point safety belt to concurrently secure a child restraint system and child.
- Before every trip, make sure that the vehicle's lap shoulder 3-point safety belt is firmly fastened over the child seat, and the child is secure.
- Verify that H-shaped harness of the Booster Seat is at the position that guarantees the lap belt stays appropriately to hold the hip of the child as snugly as possible.
- If you are unsure about the appropriate positioning of your child in the child restraint system, consult your dealer for immediate support.
- Reconfirm that the 4-point harness is not twisted and that the child is properly secured.

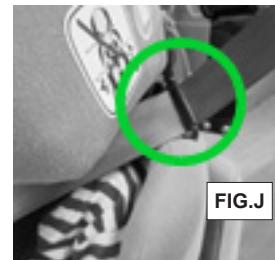



WARNING!

It is your **RESPONSIBILITY** to use the Vehicle's Safety Belts.

It is **NOT** sufficient to secure a child only with the 4-point harness straps of child restraint system. It is required by law to always use the vehicle's lap shoulder 3-point safety belt concurrently to secure a child seat and child.

Failure to use the vehicle's lap shoulder 3-point safety belt could cause your child restraint system not to perform as intended and place your child at serious risk.

The figure below illustrates the correct placement of the shoulder 3-point safety belt over the child restraint system.

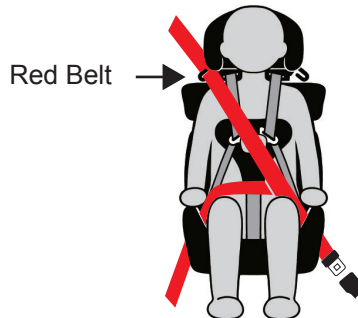

Secure Occupant

- Always pull on the harness after securing the occupant to ensure the buckle tongues are secure in the harness buckle.
- Always park your car in a safe place when you make any adjustments to the child restraint system, including reclining the car seat. Adjusting and / or handling the child restraint system during driving could cause **SERIOUS INJURY** to you and your child.
- During driving, the child restraint system must be used in an upright position. Reclined position could cause the child restraint system not to perform as intended in a collision.

Care and Maintenance

Do not try to remove or replace the cover by yourself as it needs special equipment. Consult your dealer for removal or replacement of the cover.

Cleaning the Cover, Pillow and Pads

For the Cover, SPONGE CLEAN using cold water and mild soap. TOWEL DRY. For the Pillow and Pads and Cushions, HAND WASH using cold water and mild soap. LINE or LIE FLAT DRY to prevent from shrinking. Do not Bleach, machine wash, machine dry or iron. Washing may damage fabric. It is important to keep upholstery clean. Periodic replacement is recommended.

When fabric is damaged, it must be replaced. The harness buckle needs to be periodically checked for performance. If a click is not heard, it is time to replace the harness buckle. Ask the dealer for replacement of the harness buckle, which must be done by your dealer.

Harness & Straps

Do not take apart, or attempt to take apart, the harness and the straps from the child seat. Never remove the buckles and / or the buckle tongues from the harness or the straps. They cannot be reattached after removal. If reassembled incorrectly, the child seat may not perform as intended.

Product

Overall Width	20" – 22" (510-560 mm)
Seat Depth	17" (440 mm)
Seat Width	16.5" (420 mm)
Extendable Backrest Height	28" – 33" (720-845 mm)

Product Weight	21lbs (10.5kg)
Target User Weight	81lbs (36-75 kg)
Target User Age	14 years-Adult

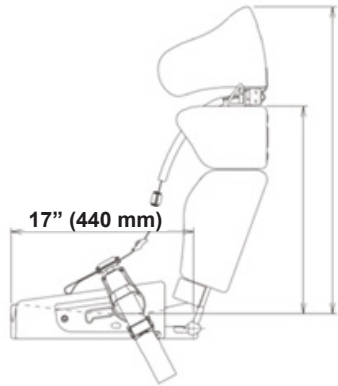
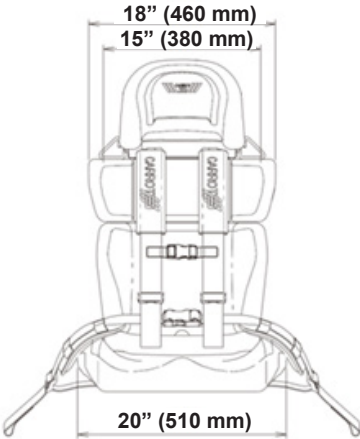

Warranty

LIMITED WARRANTY

Product Model: **CARROT-3 Booster Seat**

Name: _____

Street Address: _____

City: _____ State: _____

Zip Code: _____ Country: _____

Phone Number: _____

Email Address: _____

Lot Number: _____

Serial Number: **CT3** - _____

Manufactured Date: _____

Date of Purchase: _____

Dealer: _____

Warranty

LIMITED FIVE YEAR WARRANTY

This product is warranted against defective materials and workmanship for five years from the date of original purchase. Proof of purchase is required.

To make a claim under this warranty, contact the authorized dealer or the retailer whom you purchased this product from.

WARRANTY LIMITATIONS

This warranty does not include damages which arise from negligence and/or misuse not in accordance with the product instruction.

The use of other (non-Carrot 3 Booster Seat) covers, inserts, toys, accessories, or tightening devices is not approved. Their use could cause this child seat to fail Safety Standard FMVSS 213, or not perform as intended in a crash. Their use automatically voids this warranty.

LIMITATION OF DAMAGES

The warranty set forth above is exclusive and in lieu of all others, oral or written, express or implied. In no event will the manufacturer, the distributors, or the retailers selling this product, be liable for any damages, including incidental or consequential damages, arising out of the use or inability to use this product.



2830 California Street, Torrance, CA 90503
(888) 266-8243 • (310) 618-0111 • Fax: (310) 618-2166
Website: www.convaid.com · Email: sales@convaid.com